

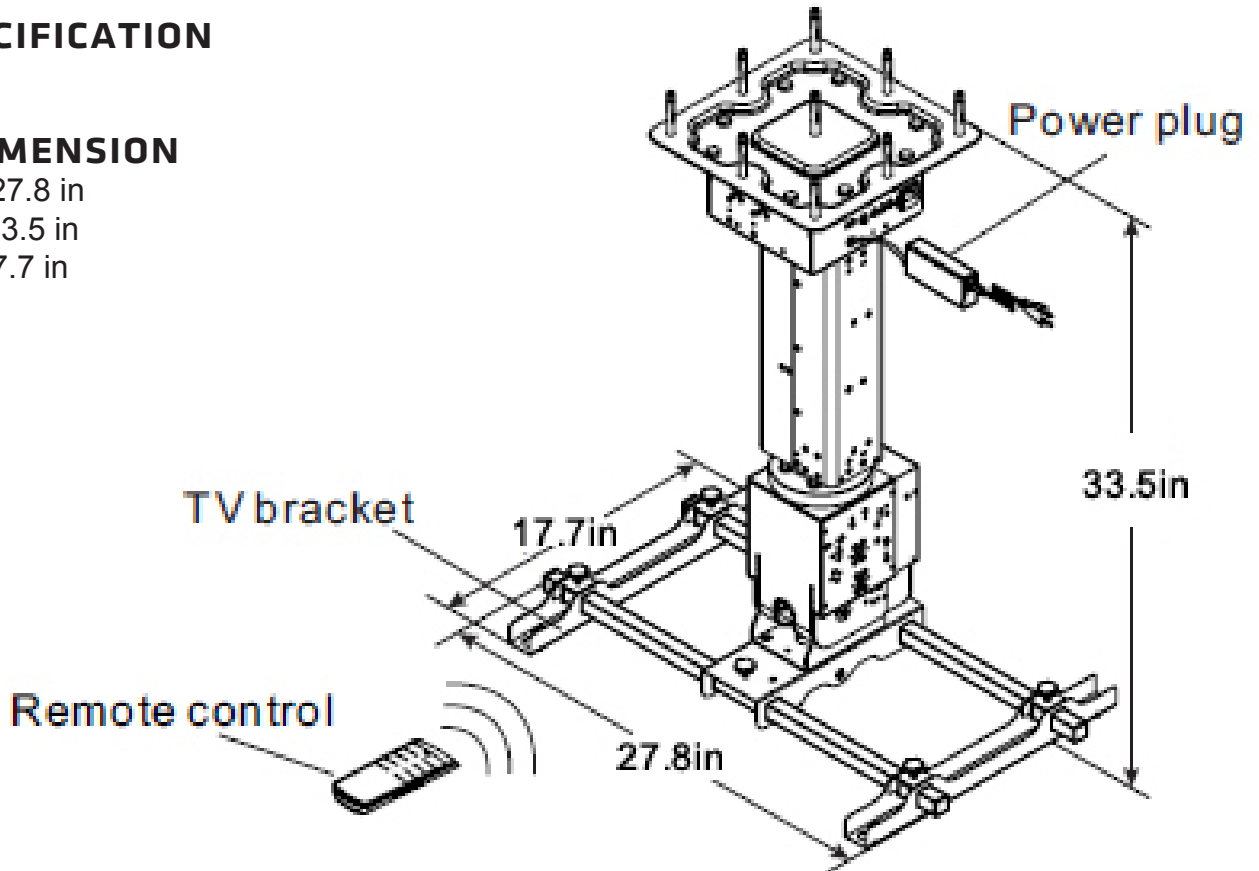









1. SPECIFICATION

1-1. DIMENSION

Length: 27.8 in
Height: 33.5 in
Width: 17.7 in



1-2. INSTALLATION PARTS:

① 2pcs  Sink head screw M5/M6/M8 (mm)	② 2pcs  Tab M5/M6/M8(mm)	③ 2pcs  Round head screw M5/M6/M8 (mm)	④ 2pcs  Washer M5/M6/M8(mm)	⑤ 2pcs  Pad M5/M6/M8(mm)
⑥ 9pcs  M8*70mm Expansion screw	⑦ 6pcs  M6*18mm Plastic-head Screw	⑧ 1 pcs  Remote control	NOTICE 1: Use originals only, any other unapproved components may result in the falling off of TV and this bracket.	

NOTICE 2:

Check all the parts as shown on the manual included. If parts are missed or damaged, do not use it and please return to your local distributor.

1.3 ASSEMBLY TOOLS (NOT INCLUDED)



2. ELECTRIC SPECIFICATION

2-1. INPUT VOLTAGE/CURRENT/FREQUENCY:

100-240VAC, 1.2A,50/60Hz

Output Current: DC24V ,3A

2-2. MOTOR

Motor	Rated Voltage	Current (No load)	Current (Rated load)	Operation Temperature
DN3435-3046E	DC24V	≤ 0.5 A	≤ 2 A	-20 C ~ -50 C
PR545AG-12300-IG32-721	DC24V	≤ 0.3 A	≤ 0.5 A	-20 C ~ -50 C

WARNING:

1. Incorrect installation may result in fall off of TV and this bracket and personal injuries.
2. Ceiling mounting of this bracket is out of the responsibility of manufacturer shall be carried out by competent persons, or licensed person, with using the attached anchors (Ø10-M8x70) only to ensure the safety.
3. Use this bracket properly, please read the instructions carefully before installation. Keep this guide well for further reference.
4. The user must pay attention to the weight of TV and This product, and only solid wall (the wall must be make up of concrete or brick) can support the weight . Please complied with the installation instruction of LCD/PDP to install them.
5. Do not attach the TV on the bracket before installations.

3. INSTALLATION INSTRUCTION

3-1. Firstly,please make sure the wall thickness for TV wall mount is at least 80mm and the osition where you want to install the TV do not have any rigid materials(such as : reinforcing steel bar , steel block ,etc) and any loose phenomena. Make the mark at the place of ceiling that you ant to mount the TV. Use percussion borer to drill 9 holes on the mark, at Φ10mm and 75 depth .Take out 9 pcs (6) expansion screws from the fitting bag, insert them through the holes of cart into the hole of ceiling by hammer and fasten them by wrench. (See diagram 1)

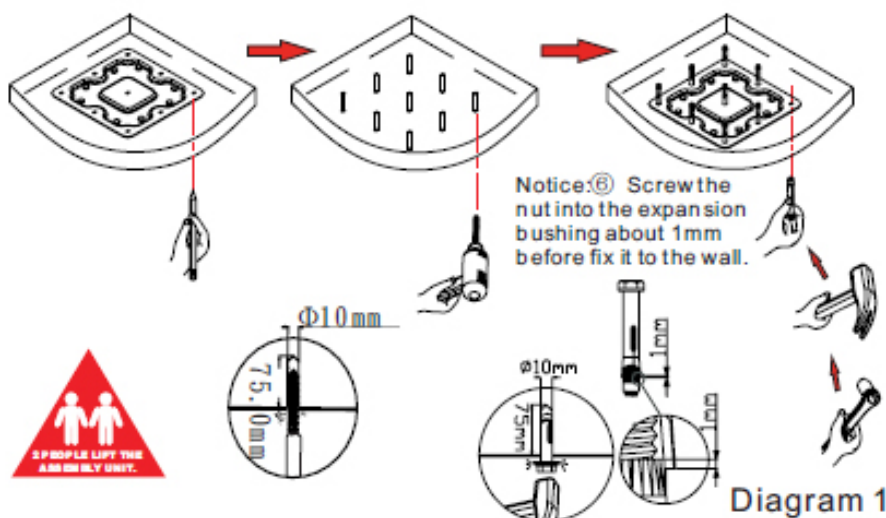

3-2. Screw off 8pcs nuts from the mounting plate, lift the main body by two people, aim at the 8pcs screws on the mounting plate, then fasten the main body to mounting plate by 8pcs nuts. Take out the power plug from carton. Insert one end to TV cart and other end to power supply. (See diagram 2)

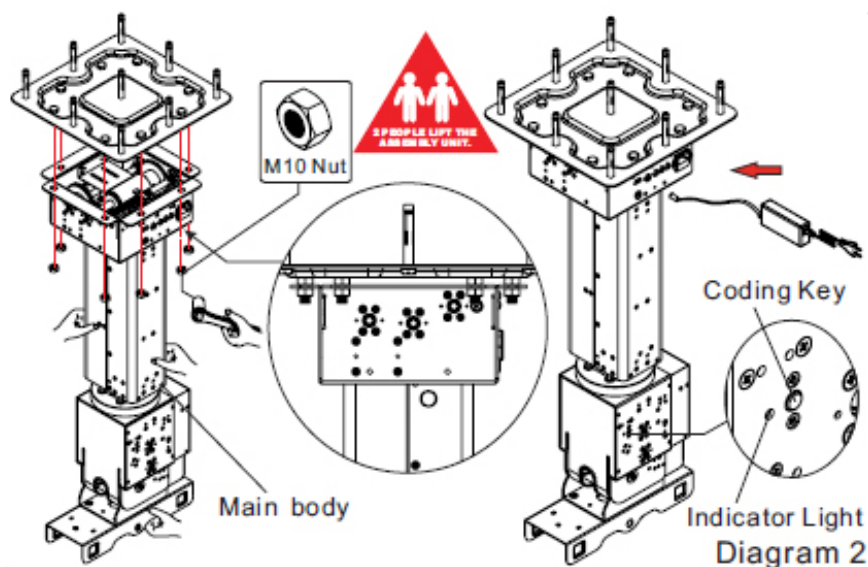

3-3. Insert square tube into conjunctive bracket and fasten them by 2pcs (7) plastic-head Screw. Install the TV bracket to square tube, adjust the distance according to the hole position of the TV, fasten them by 4pcs (7) plastic-head screws; Then press the "ON" on the remote control to make the TV bracket to vertical position. (See diagram 3)

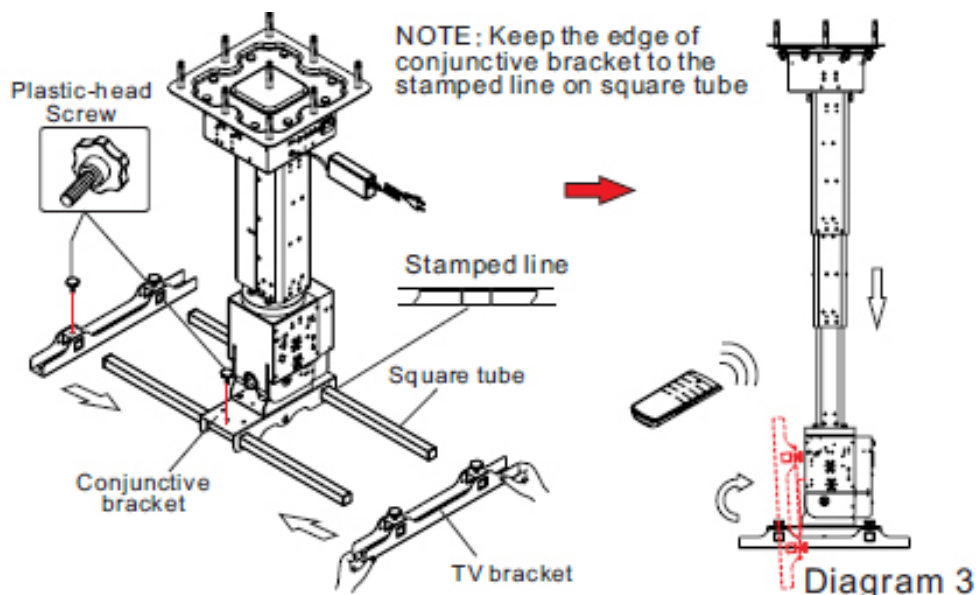

3-4. Fasten (2) tab on the upper end of TV back panel by (1) sink head screw. Check fastness, then hook TV on the cart's TV bracket. (see the diagram 4)



3-5. Through (4) washer and slot of TV bracket and (5) pad, (3) pan head screw fasten the down side of TV. (5) Pad should be placed between TV bracket and TV. (see the diagram 5)

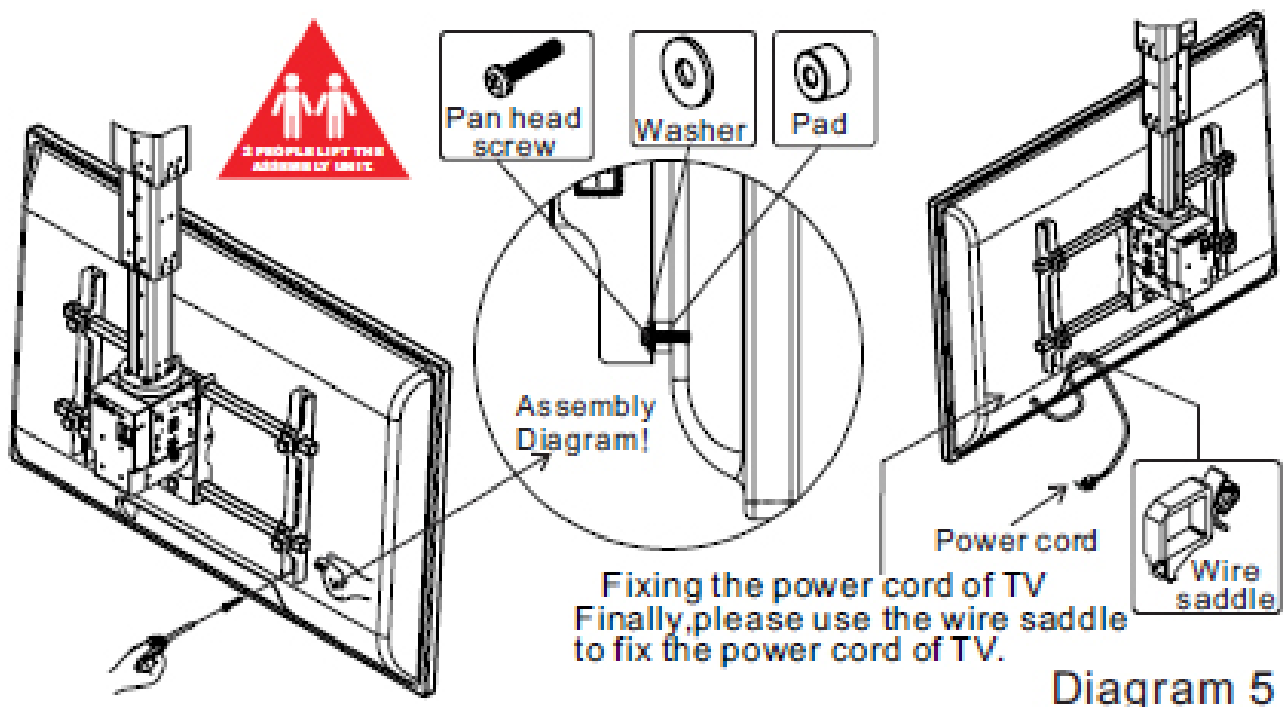

4. OPERATING INSTRUCTION.

4-1. FUNCTION

Using remote control can turn TV left or right to angel 35 and tilt up or down to 87 angel (vertical or horizontal), lower length is 500mm. (See diagram 6&7)



Diagram 6

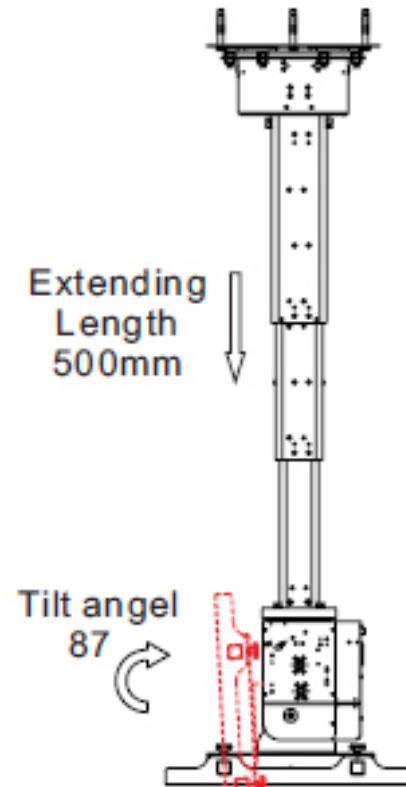

Diagram 7

4. TECHNICAL PARAMETERS:

Item Model	TV Screen Size (inch)	Cart Dimension	Max Installation Size (inch)	Min Installation Size (inch)	Loading (lbs)	L/R angle (°)	Extending Length(in)	Net Weight (lbs)
NY-22	32~42"	27.8"x 17.7"x 33.5"	23.6 x 15.7	15.7 x 7.9	110.2	± 35	0~19.7	74.7 ±1

WARNING:

This ceiling mount is intended for indoor use only with the maximum weights indicated ,Use with heavier than the maximum weights indicated may result in instability causing possible injury!

5. CAUTION:

- Do not connect before fasten the product.



- Make sure wire and plug are good before connecting.

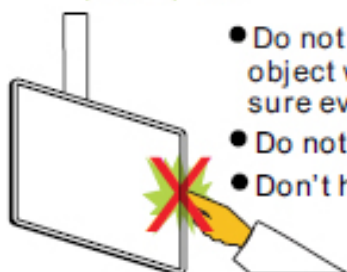
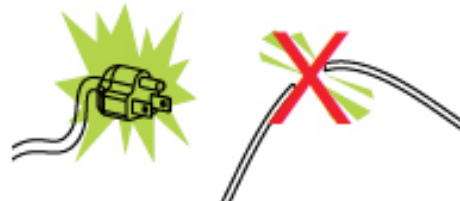

- Do not touch or push the product by hand or other object when it is working . Check carefully to make sure every parts are fastened tightly before use.
- Do not use outdoors unless marked for outdoor use.
- Don't hang other weights on this bracket!

6.2. REMOTE CONTROL (See diagram 6):

6-2.1. KEY FUNCTION

1. LEFT: Hold on to turn TV left
2. RIGHT: Hold on to turn TV right
3. UP: Hold on to tilt TV up
4. DOWN: Hold on to tilt TV down

ON: One push to extend cart to the programmed operating position automatic all. (Vertical position)

OFF: One push to back cart to the programmed storage position automatically. (Horizontal position)

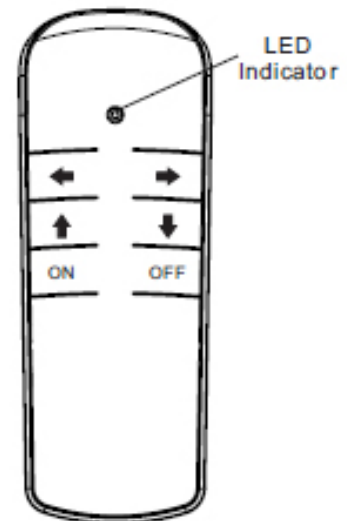

6-2.2. OPERATION INSTRUCTION

1. Aim the LED indicator on remote control at TV. The remote range is 3-10m.
2. When you press one of the function key on remote control straightly (raise, lower, left, right, up, down) the mount will move to the direction you expected. Loosening, the mount will stop.
3. Insert one 23A,12V battery in the remote control. If the battery ran out, please open the back cover of the remote control and put in the new one.

6-2.3. NOTICE:

If any remote control of our product was lost or damaged, you can buy a new remote control with the same frequency which produced by our company and do following operation:

1. Memory cleaning: pressing coding key about 10 seconds, the memory will be cleaned after the indicator closed. (The memory is the coding memory of the previous remote control)
2. Use new remote control: pressing any key of remote control and the coding key 1-2 seconds at the same time, loosening remote control firstly, then loosen the coding key, finally, you can operate the product with new remote control. (Coding key, Indicator, Please see diagram 2)

WARNING: The top insert holes of main body is for power input, TV signal input, VIDEO and AUDIO signal input. The outside signal can be send to main body through it, do not connect with the inserts holes of TV directly. Please operate it strictly according to the installation instruction, otherwise manufacturer will not bear compensation and law obligation for any damage and safety problem.

WARNING: The base insert holes of main body is only to connect the terminal of power input, TV signal input, VIDEO and AUDIO signal input of TV. Please operate it according to the installation instruction, otherwise manufacturer will not bear compensation and law obligation for any damage and safety problem.

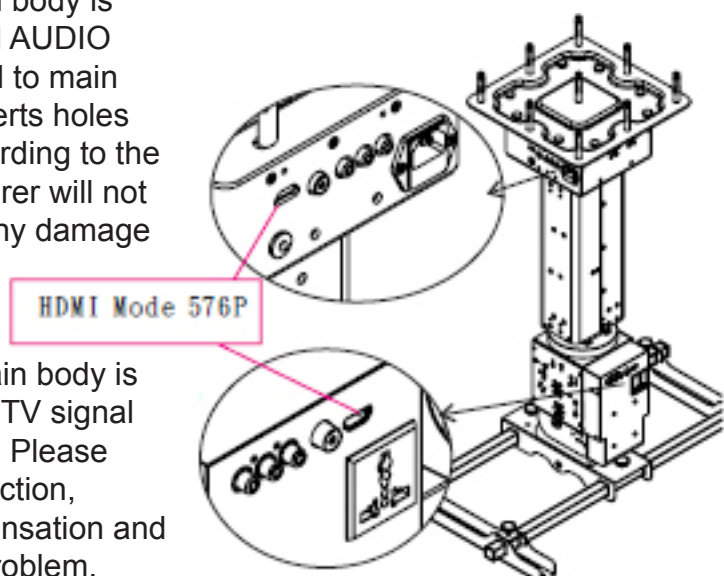

7. MAINTENANCE

Unplug the powers of this bracket& FPD before maintenance is engaged in and follow the instructions described in FPD 's manual for daily maintenance of TV& bracket. Do not use corrosive agent or alcohol or chemical cloth to clean!

4. RELIABILITY

Temperature and humidity condition: -20 C - +50 C, 80%HR

WARNING:

1. Do not disassemble the product to repair by yourself. Warranty for electricity is void after disassembled!
2. After you installed the apparatus, please check the expansion screws and all fastening devices every 3 months, and please do not use it and contact the local dealer if gets loose, rusty or lost.
3. The drive component of this product is uncontinual drive component. If need to work continually, you must stop 2 hours after working 8 hours!
4. This appliance is not intended for use by persons (including children) with reduced physical, sensory or mental capabilities, or lack of experience and knowledge, unless they have been given supervision or instruction concerning use of the appliance by a person responsible for their safety.
5. Children should be supervised to ensure that they do not play with the appliance.

HINT OF HOW TO DISPOSE:

- Do not dispose of electrical appliances as unsorted municipal waste, use separate collection facilities.
- Contact your local government for information regarding the collection systems available.
- If electrical appliances are disposed of in landfills or dumps, hazardous substances can leak into the groundwater and get into the food chain, damaging your health and well-being.
- When replacing old appliances with new once, the retailer is legally obligated to take back your old appliance for disposal at least for free of charge.

